

A background image of water splashing, with a vertical stream of water falling from the top and a larger splash at the bottom. The water is rendered in a light, semi-transparent style against a white background.

Waterproof Connectors

Section 11

Waterproof Connectors

IP68 Cable Connectors



The Range

Product Code	Product Description	Current Rating	Temperature Rating	Conductor Size	IP Protection
FCN-16245	3 Pole Cable Connector	32Amps 415Vac	85°C	4mm ²	IP68
FCN-16250	5 Pole Cable Connector	32Amps 415Vac	85°C	4mm ²	IP68

Specifications & Installation

Material Specifications

Grommet:	TPE - V
Gasket:	Silicone
Tube:	PA66 UL 94 V2
Glands:	PA66 UL 94 V2
Screws:	Zinc Passivated Steel
Connector:	Nickle Plated Brass

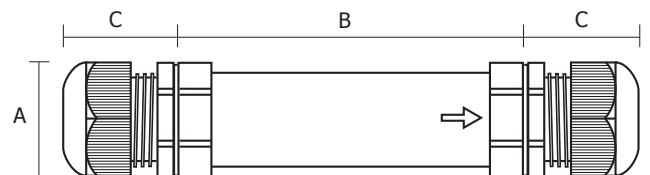

Size & Dimensions

Dimensions

	A	B	C
3 Pole	25mm	65mm	30mm
5 Pole	30mm	65mm	35mm

Cable Sizing

	Min OD Ø	Max OD Ø
3 Pole	5mm	13mm
5 Pole	8mm	17mm

Simple Installation

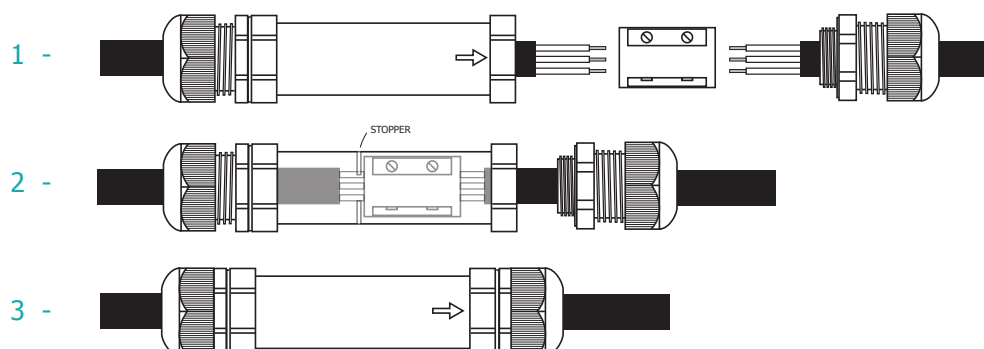

Waterproof Connectors

IP68 Quick Plug Connectors



The Range

Product Code	Product Description	Current Rating	Conductor Size	IP Protection
FCN-16260	Flex Connector Female/Male Set	16Amp	5 - 9mm ²	IP68
FCN-16262	Flex Connector Female/Male Set	16Amp	8 - 13mm ²	IP68
FCN-16264	Male Line Flex Connector	16Amp	5 - 9mm ²	IP68
FCN-16266	Female Socket Flanged Surface Mount	16Amp	5 - 9mm ²	IP68
FCN-16268	Sealing Cap - Female	16Amp	5 - 9mm ²	IP68
FCN-16270	Sealing Cap - Male	16Amp	5 - 9mm ²	IP68

Specifications & Installation

Material Specifications

Grommet:	Nitrile Rubber
Gasket:	Nitrile Rubber
Tube:	PA66 30% GF UL 94 V2
Glands:	PA66 30% GF UL 94 V2
Screws:	Zinc Passivated Steel
Connector:	Polycarbonate (PC)
Temperature Rating:	-25°C to +80°C

Simple Installation

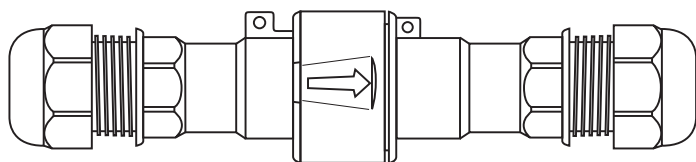

Flex Connector Female/Male Set

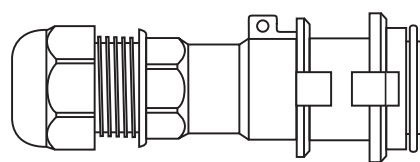

Male Line Flex Connector

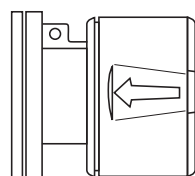

Female Socket Flanged Surface Mount

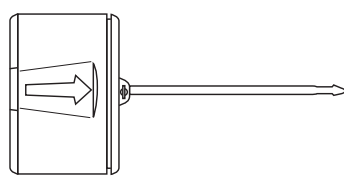

Sealing Cap - Female

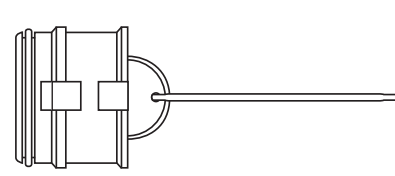

Sealing Cap - Male